

AMERICAN AVK TIMESAVER™ HDPE FUSIBLE BALL VALVE
HDPE fusible ends (IPS, DR 9, standard) - Valve sizes 2" - 6"

85/PEBV/DR9
HDPE/BV

Use:

The AVK series 85/PEBV/DR9, TIMESAVER™ HDPE fusible ball valve, has a body made from 100% high density polyethylene that can be used in a wide range of chemical, fluid, and gas applications. They are designed for quick, direct heat fusion into polyethylene piping systems, providing a leak-free system which requires no additional flange adapters, spacers, back-up rings or hardware.

Tests:

Every valve is performance tested per ASME B16.40 and AWWA C504 (no leakage allowed)
 Maximum pressure rating gas - 160 PSI
 Maximum pressure rating water - 250 PSI

Features:

100% HDPE body
 Universal valve suitable for both Gas & Water
 IPS, DR 9, HDPE fusible ends (standard)
 Safety connector; when over torqued, no leakage
 Low operating torque
 Full bore piggable ball valve without flow reduction

Standard Materials:

Valve Body, Reducer	HDPE, PE100/4710
Ball, Support Ring, Seat Retainer	
Stem	POM
Seat, O-rings	NBR-70
Ball Seat	
Operating Nut/Connector	PA-GF

Optional Extras:

Stem extensions
 Levers
 Support base up to 3" size

Approvals:

Certified to: ANSI/NSF 61, ANSI/NSF 372



Polyethylene materials meet ASTM D2513 requirements for gas piping

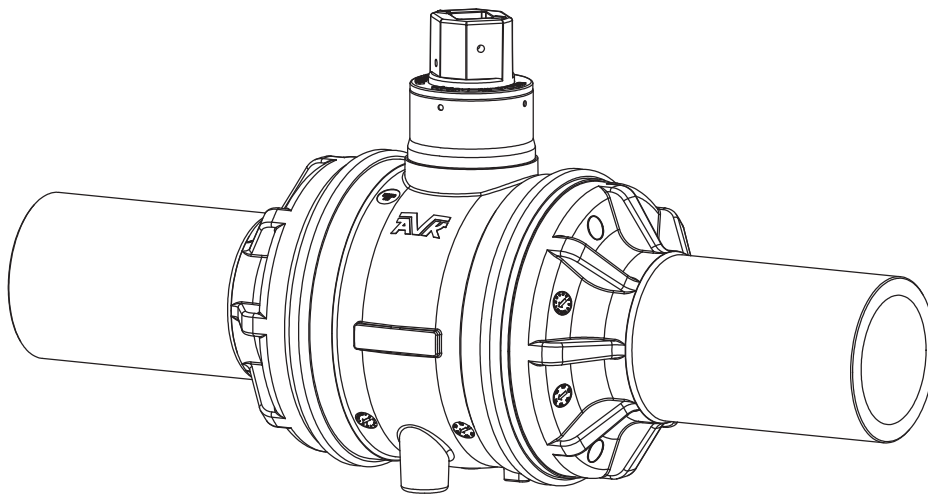

AMERICAN AVK TIMESAVER™ HDPE FUSIBLE BALL VALVE
 HDPE fusible ends (IPS, DR 9, standard) - Valve sizes 2" - 6"

85/PEBV/DR9
HDPE/BV

Components

800. Valve Body	801. Operating Nut	802. Upper O-Rings	804. Lower O-rings	805. Stem
806. Support Ring	807. Ball Seat	808. Seat Retainer	809. Ball	810. Bearing Ring
812. Reducer				

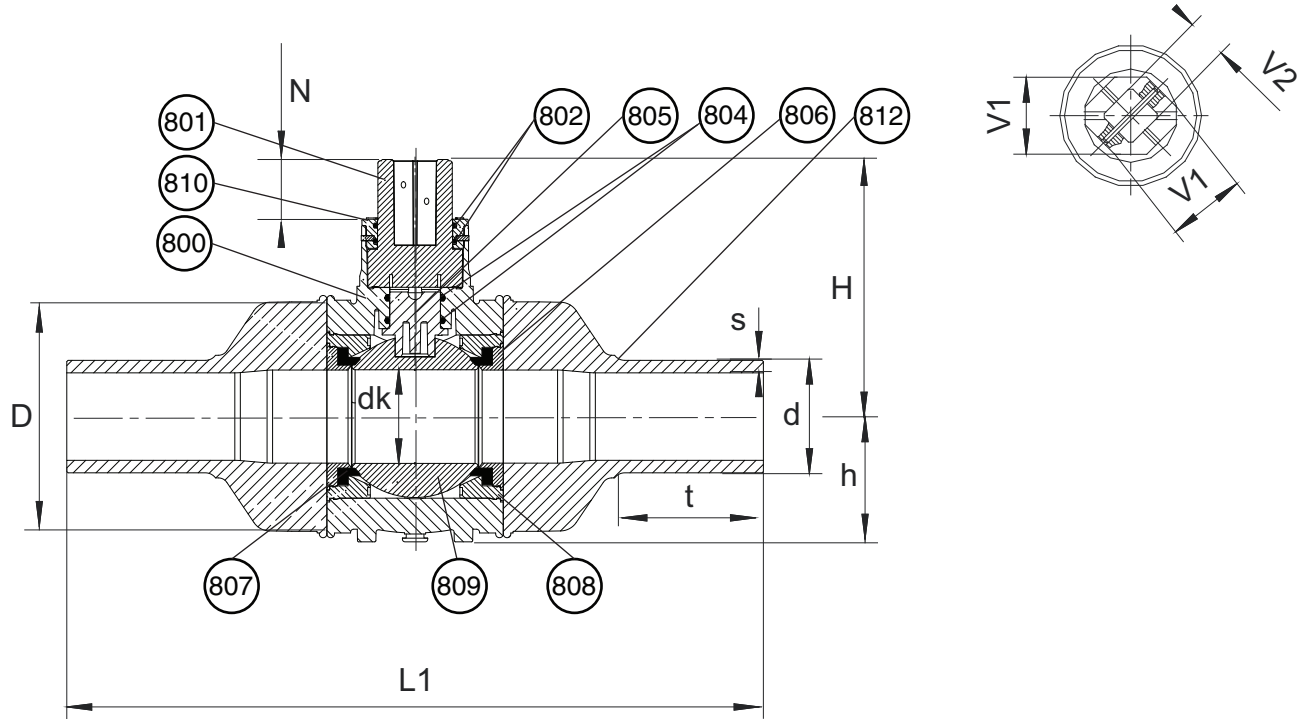

Ref No.	Size	D	d	dk	H	h	L1	N	s	t	V1	V2	Weight (lbs.)
85-050-PEBV-DR9	2"	5.46"	2.38"	1.97"	8.78"	2.38"	17.19"	1.58"	0.26"	3.98"	1.95"	1.00"	6
85-080-PEBV-DR9	3"	7.27"	3.50"	2.91"	10.24"	3.50"	21.68"	1.58"	0.39"	4.31"	1.95"	1.00"	14
85-100-PEBV-DR9	4"	8.14"	4.50"	3.39"	10.40"	4.50"	23.57"	1.58"	0.50"	4.80"	1.95"	1.00"	20
85-150-PEBV-DR9	6"	11.20"	6.63"	4.72"	12.49"	6.63"	27.05"	1.58"	0.74"	4.12"	1.95"	1.00"	47

