

**AMERICAN AVK RESILIENT SEATED DUCTILE IRON GATE VALVE** **45/PFN**  
**250 PSI, Tested to AWWA C509 / C515 (NRS)** **POxFL**  
**Push-on Joint End (TYTON) x Flanged End to ASME B16.42 Class 150 - Valve sizes 4" - 12" and 16"**

**Use:**

For water and neutral liquids to maximum 160°F.

**Tests:**

Hydraulic test to AWWA C509:

Shell Test: 500 PSI 4"-16"

Seat Test: 250 PSI 4"-16"

Operating Torque Test

**Optional Materials:**

Stem For UL, FM, ULC  
4"-12" Low Zinc Bronze ASTM B763

16" Standard: Aluminum Bronze  
ASTM B150/B150M

Anti Friction Washers Polyamide

Bolting ASTM A164 zinc coated steel ,  
Stainless Steel - 316

**Standard Materials:**

Body, Bonnet, Gland Flange, Wrench Nut	Ductile iron ASTM A536 (Wrench Nut-painted black for open left, red for open right)
Coating	Electrostatically applied fusion- bonded epoxy-resin Meets or exceeds AWWA C550
Stem	Standard: Stainless steel ASTM A582
Wedge	Ductile iron ASTM A536 encapsulated with EPDM-rubber compound
Wedge Nut, Thrust Collar	Bronze
Bonnet Bolts	Stainless Steel - 304 for 4"-8" sealed with hot melt Grade 8 Steel for 10"-12" & 16" sealed with hot melt
Gland Bolts	Stainless Steel - 304 Hexagon bolt
Bonnet Gasket, Wiper Ring, O-Ring Stem Seals, O-Ring Gland Seal	ASTM D2000 Buna "N" nitrile rubber

**Approvals:**



\*UL/ULC Listed  
 \*FM Approved  
 Certified to: ANSI/NSF 61, ANSI/NSF 372

\* Approved at 250 PSI working pressure, 4"-12"  
 \* Approved at 200 PSI working pressure, 16"

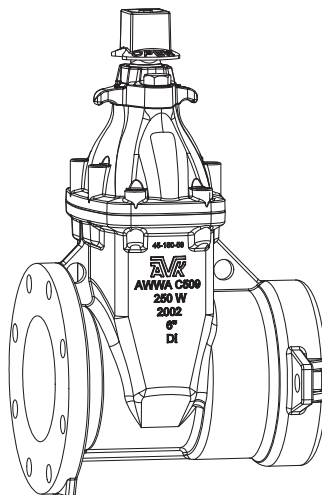

# AMERICAN AVK RESILIENT SEATED DUCTILE IRON GATE VALVE

250 PSI, Tested to AWWA C509 / C515 (NRS)

Push-on Joint End (TYTON) x Flanged End to ASME B16.42 Class 150 - Valve sizes 4" - 12" and 16"

45/PFN

POxFL

### Component List:

217. Bonnet	227. Gland Flange Bolt	232. Lower Stem Seal O-Ring
218. Bonnet Gasket	228. Gland Flange	233. NRS Stem
219. Body	229. Gland O-Ring	234. Thrust Collar
225. Wrench Nut	230. Upper Stem Seal O-Rings	237. Wedge
226. Wiper Ring	231. Stem Seal Bushing	

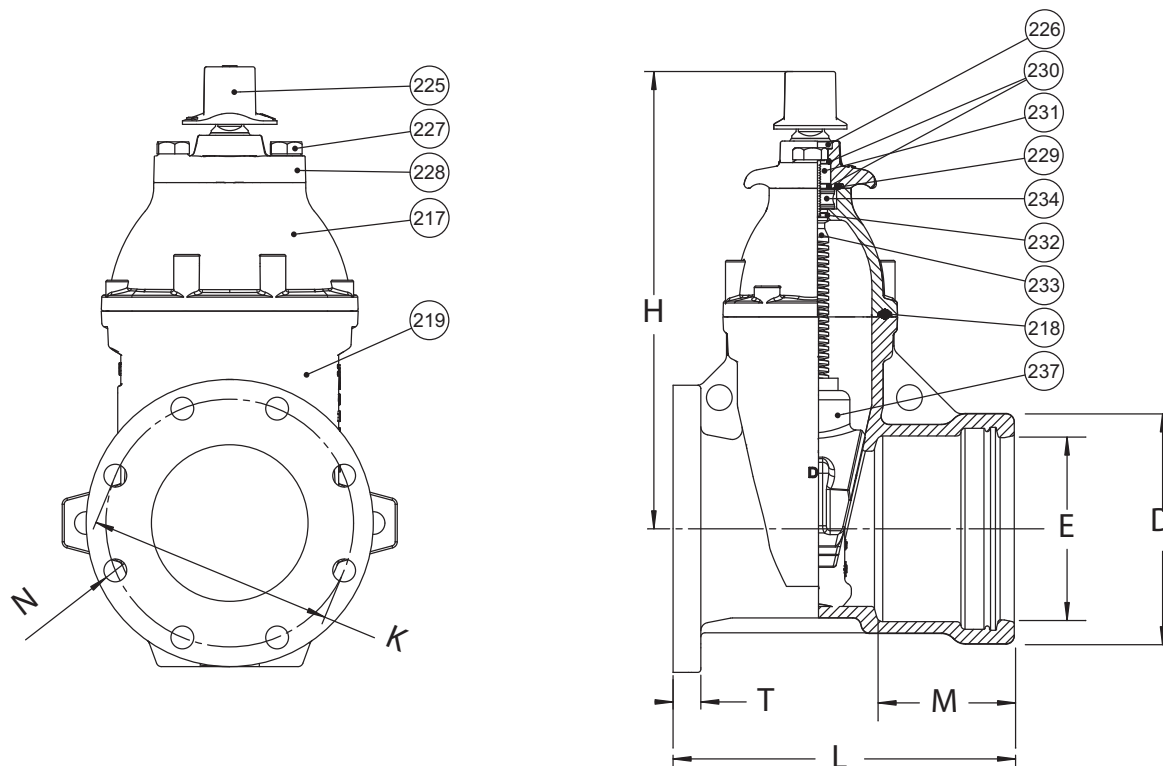

Ref No.	Size	D	E	H	K	L	M	N	T	Flange Holes	Turns to Open	Weight (lbs.)
45-100-PFN	4"	6.66"	4.93"	13.50"	7.51"	10.51"	4.12"	0.75"	1.00"	8	14	59
45-150-PFN	6"	8.84"	7.03"	17.50"	9.49"	13.07"	5.22"	0.88"	1.06"	8	20	98
45-200-PFN	8"	11.23"	9.18"	21.50"	11.73"	14.33"	5.63"	0.88"	1.14"	8	26	154
45-250-PFN	10"	13.50"	11.22"	24.75"	14.25"	15.31"	5.63"	1.00"	1.22"	12	32	232
45-300-PFN	12"	15.74"	13.32"	27.75"	17.00"	16.61"	5.63"	1.00"	1.30"	12	38	358
45-400-PFN	16"	20.62"	17.51"	34.75"	21.25"	19.35"	5.00"	1.13"	1.44"	12	51	800

